

## HB551 pH Electrodes and Accessories

70-82-25-124

Rev. 1  
10/07

---

# Copyright, Notices, and Trademarks

Printed in U.S.A. – © Copyright 2007 by Honeywell

Revision 1 – October 16, 2007

## WARRANTY/REMEDY

Honeywell warrants goods of its manufacture as being free of defective materials and faulty workmanship. Contact your local sales office for warranty information. If warranted goods are returned to Honeywell during the period of coverage, Honeywell will repair or replace without charge those items it finds defective. The foregoing is Buyer's sole remedy and is **in lieu of all other warranties, expressed or implied, including those of merchantability and fitness for a particular purpose**. Specifications may change without notice. The information we supply is believed to be accurate and reliable as of this printing. However, we assume no responsibility for its use.

While we provide application assistance personally, through our literature and the Honeywell web site, it is up to the customer to determine the suitability of the product in the application.

**Honeywell Field Solutions**  
512 Virginia Drive  
Fort Washington, PA 19034

Kynar is a trademark of Arkema.

Teflon and Viton are trademarks of E. I. DuPont De Nemours & Company, Inc.

Other brand or product names are trademarks of their respective owners.

---

# About This Document

## Abstract

This manual contains instructions for installation and use of the HB551 pH electrodes.

## Revision Notes

The following list provides notes concerning all revisions of this document.

Rev. ID	Date	Notes
0	8/07	This is the initial Honeywell release of this manual.
1	10/07	Accessory information added

## Contacts

### World Wide Web

The following lists Honeywell's World Wide Web sites that will be of interest to our customers.

Honeywell Organization	WWW Address (URL)
Corporate	<a href="http://www.honeywell.com">http://www.honeywell.com</a>
Honeywell Field Solutions	<a href="http://www.honeywell.com/Cultures/en-US">http://www.honeywell.com/Cultures/en-US</a>
International	<a href="http://www.honeywell.com/Business/global.asp">http://www.honeywell.com/Business/global.asp</a>

### Telephone







Contact us by telephone at the numbers listed below.

	Organization	Phone Number
United States and Canada	Honeywell	1-800-423-9883 Tech. Support 1-888-423-9883 Q&A Faxback (TACFACS) 1-800-525-7439 Service
Asia Pacific	Honeywell Asia Pacific Hong Kong	(852) 2829-8298
Europe	Honeywell PACE, Brussels, Belgium	[32-2] 728-2111
Latin America	Honeywell, Sunrise, Florida U.S.A.	(854) 845-2600

---

## Symbol Definitions

The following table lists those symbols used in this document to denote certain conditions.

Symbol	Definition
	This CAUTION symbol on the equipment refers the user to the Product Manual for additional information. This symbol appears next to required information in the manual.
	<b>WARNING</b> <b>PERSONAL INJURY:</b> Risk of electrical shock. This symbol warns the user of a potential shock hazard where HAZARDOUS LIVE voltages greater than 30 Vrms, 42.4 Vpeak, or 60 Vdc may be accessible. <b>Failure to comply with these instructions could result in death or serious injury.</b>
	ATTENTION, Electrostatic Discharge (ESD) hazards. Observe precautions for handling electrostatic sensitive devices
	Protective Earth (PE) terminal. Provided for connection of the protective earth (green or green/yellow) supply system conductor.
	Functional earth terminal. Used for non-safety purposes such as noise immunity improvement. NOTE: This connection shall be bonded to protective earth at the source of supply in accordance with national local electrical code requirements.
	Earth Ground. Functional earth connection. NOTE: This connection shall be bonded to Protective earth at the source of supply in accordance with national and local electrical code requirements.
	Chassis Ground. Identifies a connection to the chassis or frame of the equipment shall be bonded to Protective Earth at the source of supply in accordance with national and local electrical code requirements.

---

# Contents

<b>1.</b>	<b>INTRODUCTION .....</b>	<b>1</b>
1.1	About This Manual.....	1
1.2	Overview .....	1
1.3	Maximum process pressure and temperature .....	2
1.4	Wetted parts resist corrosion .....	2
<b>2.</b>	<b>FEATURES &amp; SPECIFICATIONS.....</b>	<b>3</b>
2.1	Features .....	3
2.2	Specifications .....	3
<b>3.</b>	<b>ACCESSORIES .....</b>	<b>5</b>
<b>4.</b>	<b>SENSOR PHYSICAL CHARACTERISTICS .....</b>	<b>7</b>
4.1	Questions .....	7
4.1.1	What is a pH Sensor? .....	7
4.1.2	What is a Sensor's Measuring Electrode? .....	7
4.1.3	What is a Sensor's Reference? .....	7
4.1.4	What is Axial Ion Path (AIP) Reference (technology patented by Barben Analyzer Technology)? .....	7
4.1.5	What is a Liquid Junction? .....	7
4.1.6	What is a T.C. (Temperature Compensator)? .....	7
4.1.7	What is a Solution Ground? .....	8
4.2	Affects on the Measurement.....	8
4.2.1	How does temperature affect pH measurement? .....	8
4.2.2	What common conditions affect the Sensor Reference causing pH measurement error? ...	8
4.2.3	What other conditions may affect the Sensor Reference? .....	8
4.2.4	What conditions affect the Measuring Electrode? .....	9
<b>5.</b>	<b>CALIBRATION.....</b>	<b>10</b>
5.1	About Calibration .....	10
5.1.1	Calibration .....	10
5.1.2	What are buffers? .....	10
5.1.3	What is a one-point calibration? .....	10
5.1.4	What is a two-point calibration? .....	10
5.1.5	What is a three-point calibration? .....	10
5.2	Single Point Calibration and Sensor Verification .....	11
5.2.1	Background .....	11
5.2.2	Buffers .....	11
5.2.3	Problems with buffers and process sensors .....	11
5.2.4	Junction potential .....	12
5.2.5	The right way to calibrate hot process control sensors.....	12

---

5.2.6	How do we know if the sensor is dead? .....	13
5.2.7	Summary.....	13
<b>6.</b>	<b>STORAGE AND MAINTENANCE PROCEDURES FOR PH AND ORP SENSORS</b>	<b>15</b>
<b>7.</b>	<b>ELECTRICAL CONNECTIONS .....</b>	<b>16</b>
7.1	Inputs and Outputs to the UDA2182 .....	16
7.1.1	Introduction .....	16
7.1.2	Accessing the terminals .....	16
7.2	HB Series 551 pH/ORP Input Wiring Diagrams.....	18
<b>8.</b>	<b>PRESSURE AND TEMPERATURE CHARTS .....</b>	<b>19</b>
8.1	HB Series Body Material Pressure and Temperature Ratings.....	19
<b>9.</b>	<b>DRAWINGS.....</b>	<b>21</b>
9.1	HB551 Complete Assembly .....	21
9.2	HB551 Nut-Loc Assembly .....	22
9.3	HB551 Dimension Drawing.....	23

# 1. Introduction

## 1.1 About This Manual

### Manual part of a set

This manual is part of a set documenting installation and use of the HB551 pH Electrodes and associated accessories.

The set consists of the following manuals:

- this manual (70-82-25-124)
- Instruction manual for the pH instrument.

### What this manual contains

This manual contains instructions for the installation and use of the HB551 pH electrodes and associated accessories.

### CAUTION

Read the electrode manuals before installing and using the HB Series electrodes. Failure to follow the installation instructions could result in damage to the equipment.

## 1.2 Overview

HB 551 pH electrode Models are robust and chemically resistant pH/ORP sensors. **HB551 sensors are specifically designed for quick installation and removal using the unique “Nut-Loc” adapter.** Flexible installation allows customers to reduce inventory costs and differing types of sensors required in stock.

HB Series pH sensors are compatible with competitors electronics, 551 Models are factory configured with reference wiring on the Coax Shield. Description

**Designed** for longer lasting performance, minimal maintenance and customer convenience. The



chemically resistant HB551 sensor is quick change capable when installed with a 1” Nut-Loc adapter, providing unparalleled safety and ease of removal/installation for inspection and cleaning.

**Extreme Duty** Axial Ion Path (AIP) reference. All HB sensors are manufactured under Barben Analyzer Technology patents. A large multi-segment solid-state reference permanently infused with potassium chloride (KCl), separated by a series of Axial Ion Paths, out performs the competition in longevity and resistance to poisoning.

**Features** in stock and ready for delivery include; Kynar, Polypropylene or CPVC body; ruggedized pH glass; recessed, dual notch and flush – wood or porous Teflon liquid junction; pH thermocompensation; customizable insertion depths for 3/4” or 1” NPT mounting threads; and a flexible TPE jacketed cable.

### 1.3 Maximum process pressure and temperature

The HB551 pH electrodes are to be used in a variety applications depending upon body material choice:

- ✓ Polypropylene Body: Max Temp = 100°C                      Max Pressure = 100 psig
- ✓ CPVC Body:                      Max Temp = 100°C                      Max Pressure = 100 psig
- ✓ Kynar Body:                      Max Temp = 140°C                      Max Pressure = 150 psig

### 1.4 Wetted parts resist corrosion

The electrode body is made from a choice of Kynar, Polypropylene or CPVC all of which are resistant to corrosive solutions over a wide range of temperatures. Sample solutions come into contact with the body material, wood or porous Teflon, Viton or EPDM o-ring, and glass materials of the electrode.



## 2. Features & Specifications

### 2.1 Features

Features		
<b>HB551 Electrode</b>		
<ul style="list-style-type: none"> <li>• Uses Axial Ion Path reference technology</li> <li>• One electrode for entire pH and temperature ranges.</li> <li>• <b>Intended for quick-change in-line applications</b></li> <li>• <b>Ideal for sample lines and valve side-streams</b></li> <li>• Integral automatic temperature compensator</li> </ul>	<ul style="list-style-type: none"> <li>• Chemically resistant CPVC, Kynar or Polypropylene body</li> <li>• User can specify following:                             <ul style="list-style-type: none"> <li>• Body Material</li> <li>• O-Ring Material</li> <li>• Measuring Electrode</li> <li>• Tip Configuration</li> <li>• Thermocompensation</li> <li>• Insertion Depth</li> <li>• Cable Configuration</li> <li>• Lead Terminations</li> </ul> </li> </ul>	<ul style="list-style-type: none"> <li>• Great for high temperature and high pressure applications</li> <li>• Can be used in both low and high pH conditions</li> <li>• Utilizes an external nut-loc to improve safety</li> <li>• Compatible with most industrial transmitters and analyzers</li> </ul>

Table 2-1: Feature Summary

### 2.2 Specifications

Electrode	
<b>Pressure and Temperature Rating</b>	CPVC & Polypropylene: 100 psig, 100°C Kynar: 150 psig, 140°C
<b>Operating Range</b>	0 – 14 pH
<b>Mounting</b>	<p><b>Quick-change in-line:</b> 1" MNPT threaded adapter for installation into process, sample line or automatic cleaning system. Nut-loc retainer for quick removal and replacement</p> <p><b>Submerged:</b> 3/4" MNPT threaded top for connection to 3/4" FNPT coupling and extension pipe</p> <p><i>See Accessories in Model Selection Guide</i></p>
<b>Wetted Materials</b>	Kynar, Polypropylene, CPVC (Body Material Choices) Teflon, Viton or EPDM, Wood and Glass
<b>Dimensions</b>	Dependant upon user specifications
<b>Weight</b>	Approximately 0.23 kg (0.5 lb)

Table 2-2 Specification Summary



### 3. Accessories

#### Accessory Summary

Description	Part Number
Adapter Nut-Loc CPVC 1" MNPT Kynar 1" MNPT 316SS 1" MNPT Kynar 1" MNPT with 316 SS hex nut 316SS 1" MNPT with 316 SS hex nut	  50027407-001 50027407-002 50027407-003 50027407-004 50027407-005
Extension Cables (only compatible with lead termination = B2) 10' 20' 50'	  50027414-001 50027414-002 50027414-003

**Table 3-1 Accessory Summary**



---

## 4. Sensor Physical Characteristics

### 4.1 Questions

#### 4.1.1 What is a pH Sensor?

Essentially a pH sensor is a battery made from a Measuring Electrode and a Reference. These two parts generate a voltage differential. The total voltage created by the battery is the difference in voltage between the two parts.

#### 4.1.2 What is a Sensor's Measuring Electrode?

This is an element, which produces a proportional voltage to the pH of a measured solution. When coupled with a reference it sends a millivolt signal to a transmitter / indicator which converts that voltage to a pH reading.

#### 4.1.3 What is a Sensor's Reference?

This is a constant voltage battery cell, typically made from a Silver/Silver Chloride element and Potassium Chloride electrolyte (usually a liquid, gel, or semi-solid state form). The output voltage (in millivolts) is then bridged to the measuring electrode by way of the specimen fluid (solution being measured).

#### 4.1.4 What is Axial Ion Path (AIP) Reference (technology patented by Barben Analyzer Technology)?

Like other rugged semi-solid state references it is formed by a series of wood segments impregnated with KCl. The difference is where others utilize an epoxy or impermeable barrier between each of the wood segments; we use a pair of formed discs. When the two formed disc faces are positioned adjacent to one another they form an Axial Ion Path (filled with electrolyte) between each of the segments. The Axial Ion Path provides a more complete transition of KCl ions between the wood segments forward and creates a difficult and longer distance for poisons traveling back into the reference from the specimen fluid.

#### 4.1.5 What is a Liquid Junction?

This is a porous surface, which passes ions between the reference and measurement fluid. The primary function is to allow very small amounts of KCl (Potassium Chloride) to leach from the reference and provide the millivolts necessary for pH measurement. The secondary function is to maintain a barrier between the measurement fluid and the reference so that the measurement fluid does not rapidly poison or foul the reference.

#### 4.1.6 What is a T.C. (Temperature Compensator)?

This is typically a component (RTD, Resistor, Thermistor) that produces a proportional resistance to the temperature of a measured solution. The resistance is understood by the pH Transmitter/Indicator so it can make adjustment to the measurement slope to match the effect of temperature on the sensor. With conventional glass measuring electrodes the T.C. is typically located near the measurement bulb to reduce the time necessary to recognize changes in solution temperature, allowing clearance for removal of electrode from assembly.

### 4.1.7 What is a Solution Ground?

This is a corrosive resistant conductive material in contact with the process fluid. The primary purpose is to provide a ground path to the indicator/transmitter, usually through the sensor and by a wire through the sensor cable. Some transmitters and indicators have diagnostic capabilities that use the solution ground for identifying measuring electrode failure, detection of ground loops, etc.

## 4.2 Affects on the Measurement

### 4.2.1 How does temperature affect pH measurement?

An increase in fluid temperature will raise and a decrease will lower the measurement slope from the original calibration. With conventional glass measuring electrodes, there is no temperature affect at exactly 7 pH, however, the further the measurement gets from 7, the more effect. A pH sensor with a T.C. (Thermocompensator) should be chosen for all solution measurements where any temperature changes are expected, this will adjust the measurement slope for temperature effect.

It should also be recognized that temperature directly affects the actual pH of all solutions. It is impossible to predict the effect temperature will have on all but the most elementary of solutions, due to the effects of the chemical composition.

### 4.2.2 What common conditions affect the Sensor Reference causing pH measurement error?

Process scale buildup on the Sensor Reference increases resistance to the millivolt output of the Reference itself. Keeping the Sensor Reference clean is essential for accurate pH indication.

The output voltage of the Sensor Reference can change for a myriad of reasons, hence calibration of the transmitter / indicator should be periodically checked for accuracy.

The most common conditions deal with poisoning and loss of electrolyte.

When the Sensor Reference gives up ions of KCL (Electrolyte) for the purpose of pH measurement, other ions move back into the Sensor Reference from the solution. As these foreign ions become more concentrated within the Sensor Reference and choke off the efficiency of the battery, measurement errors occur.

Loss of electrolyte is inevitable, however, solutions of very low ionic strength require much larger amounts of KCL (Electrolyte) for voltage than those with near the same ion content as the Sensor Reference itself. Over prolonged periods of time in very low ionic strength solutions the Sensor Reference may loose too much electrolyte to maintain the calibrated slope required for accurate pH measurement.

### 4.2.3 What other conditions may affect the Sensor Reference?

The flow of a solution (ions in motion) across the Sensor Reference will affect measurement accuracy.

Chemical reactions occur with the measured solution at the liquid junction. Sometimes small voltage differentials are generated by chemical reactions or incompatibilities, affecting the overall millivolt differential of the Sensor Reference and Measuring Electrode.

#### 4.2.4 What conditions affect the Measuring Electrode?

Process scale buildup on the Measuring Electrode increases resistance to the millivolt output of the Sensor Reference. Keeping the Measuring Electrode clean is essential to accurate pH indication.

With conventional glass Measuring Electrodes, a sodium ion error is recognized above 10.0 pH. As the concentration of sodium increases the measurement slope decreases. The use of low sodium error Measuring Electrodes is a good way to overcome this problem. Note – above 13 pH, even low sodium error Measuring Electrodes exhibit errors.

Another downfall of conventional glass Measuring Electrodes is an acid error below 1.5 Ph and is usually seen as an increase in millivolt output from the sensor.

With conventional glass Measuring Electrodes, aging or chemical attack by the process produces what is referred to as asymmetric potential. Defined as voltage generated by a glass Measuring Electrode in a 7.0 pH buffer. Typically errors due to asymmetric potential are considered insignificant and doing a one-point calibration makes correction to the error.

## 5. Calibration

### 5.1 About Calibration

#### 5.1.1 Calibration

All pH sensors require occasional calibration to provide an accurate and usable pH measurement. pH probes are subject to degradation over their useful life, and there are inevitable differences from one sensor design to the next. In practice, these differences and changes can be provided for within modern transmitters and analyzers, allowing the process to be measured accurately, and to extend the useful life of the sensor by compensating for its gradually degrading signal output. In short, calibration is the technique for establishing the actual, rather than theoretical, ratio between the sensor millivolt output and the process pH. Every analyzer will have its own instructions for calibration, but the following points are generally applied.

#### 5.1.2 What are buffers?

Buffers are precisely formulated liquids used to provide a known pH for use in calibrating a sensor. They can be purchased in a variety of pH values, and are provided with specific details regarding their change in pH with respect to temperature so that the user can determine the reading that should be obtained with a high degree of accuracy.

#### 5.1.3 What is a one-point calibration?

One-point calibration is a simple but effective technique intended to optimize a pH sensor for a specific application. Typically, the operator will obtain a grab sample from the process liquid and determine its pH via lab techniques, and in a manner designed to minimize any changes in indicated pH between the process conditions and the lab conditions. This value is then entered into the analyzer as the known pH at that moment in time. Additionally, the analyzer may have a probe “efficiency” entered to establish the slope or pH to millivolt ratio. The combination of the grab sample value and the efficiency value provides a linearized output range for the process being measured. One point calibration is most often used when the expected range of pH change in the process is fairly small, such that the control loop can be tuned without requiring a high degree of precision in the pH value.

#### 5.1.4 What is a two-point calibration?

In a two-point calibration the operator uses two known buffer solutions, typically on either side of the expected process pH. The probe is inserted into one of the buffer solutions, with the analyzer being adjusted to match the expected value. The probe is then inserted into the second buffer solution with the analyzer adjusted to match the expected value. Modern analyzers use the two values to establish a linearized slope for the pH to millivolt output. The two point technique is the most academically correct, as it establishes both the slope and the offset simultaneously.

#### 5.1.5 What is a three-point calibration?

Three-point calibration is the least preferred technique, and is not accommodated by most modern analyzers. Efforts to use 3 points to calibrate the output curve are more likely to introduce reference signal errors than they are to establish a true adjusted pH signal, and so will not be addressed in detail here.



## 5.2 Single Point Calibration and Sensor Verification

How to make your process control sensors last longer and be more reliable

### 5.2.1 Background

Good industrial process control pH sensors are not built the same as lab sensors. The process sensor's design goals are ruggedness, tolerance of high temperatures and pressures, resistance to fouling and tip-contamination, and immunity to poisoning by process chemicals. Since their primary function is to provide a repeatable pH reading at or near a pre-determined set-point, it is not critical that they exhibit the same degree of "accuracy" over a wide span. The design characteristics that meet these stated goals impose a different approach to maintenance and calibration than what is used for laboratory-type sensors.

### 5.2.2 Buffers

The traditional method of pH sensor calibration is the use of 2 or 3 "buffers" of known pH value, typically 4, 7, and 10pH. The sensor is placed into these solutions and, via various data entry methods, recorded by the associated transmitter, which then calculates the sensor's slope and offset. These characteristics are used to correlate the sensor's millivolt output into its related pH value. This method is well established, and is successfully used with laboratory-style sensors. Unfortunately, the buffer method of calibration does not work as well with modern on-line process control sensors, and should in most cases be replaced by a "single point grab sample" or "process standardization" method of calibration.

### 5.2.3 Problems with buffers and process sensors

While it is risky to over-generalize, on-line process control sensors are often found in hot applications, measuring and controlling pH at values well away from neutral 7pH. This means that a buffer method of calibration requires that the sensor be removed from a hot environment and dropped into a cold (or ambient) buffer solution. This creates several problems. The first and most obvious is that pH sensors use a glass electrode, which is actually constructed of two different kinds of glass welded together. The resulting temperature "shock" has a tendency to aggravate any internal stresses in the glass or weld point, resulting in breakage. The HB sensors are aggressively component tested during manufacture in order to minimize this problem, although, inevitably, some sensors will be destroyed by the repeated hot-cold-hot-cold experience.

Secondly, buffers have a stated or nominal value (4, 7, 10, etc), but in fact these values pertain only at the standard temperature of 250C. When a hot sensor is placed into a beaker of buffer solution several things conspire against a stable and accurate reading. The first is that the sensor will begin transferring heat to the buffer, raising its temperature. If only a few milliliters of buffer are used, it does not take long to elevate the buffer temperature well above its nominal value, resulting in a significant change in its pH. If an older pH transmitter is used, it will have been instructed by the technician to expect a specific value of, for instance, 4.0 pH, when in fact the heated buffer may be down to a value of 3.8 or lower by the time the sample stabilizes and is entered into the transmitter. Caustic buffers have even worse temperature instability, with as much as 2 full pH units of difference between 250C and 1000C. This becomes an unrecognized error used by the transmitter to calculate the resulting slope and offset of the sensor.

More modern transmitters often have a feature referred to as "automatic buffer recognition tables". If so equipped, the transmitter can be instructed during configuration to know which buffers will be used, and will then refer to the corresponding pH to temperature correlation tables. Of course, for these tables to work, the transmitter must know the actual temperature of the buffer solution at the moment it is being measured.

An industrial pH sensor is a massive device, built for ruggedness and tolerance to rough handling, and containing a very large reservoir of KCl. While they are typically temperature compensated, the temperature-measuring device is usually buried in the core of the sensor and not in direct contact with the process liquid or buffer solution. In fact, it is preferable that the compensation device be buried rather than in contact with the process, as its primary purpose is to compensate for the temperature of the glass electrode rather than to measure the process temperature. The glass electrode will change temperature much more slowly than the process liquid, as the glass electrode is surrounded by the body of the sensor and heat must be transferred from the tip to the body before the resulting temperature change is apparent.

As a result, the temperature-sensing device in the sensor is measuring the core temperature of the sensor, not the temperature of the buffer solution. A typical industrial sensor requires 30 minutes for its core temperature to drop from 95°C to 25°C when immersed in 1 liter of liquid. When it is immersed in a few milliliters of buffer solution, as is typical, it can require an hour or more before the core temperature cools to match the buffer temperature (which has also been rising as it absorbs heat from the sensor). Thus, the modern transmitter will look at the temperature of the core of the sensor and assume that this is also the temperature of the buffer solution, and apply the corresponding pH/temperature table. This can result in a 4.01 buffer being interpreted as 3.8 or lower, and a 10 buffer being interpreted as 9.5 or lower. The even more unstable 12 buffer might be entered as an expected value of as low as 9.86. Clearly, the resulting calibration will not be anywhere near the actual characteristics of the sensor, and this assumes that the hot to cold experience didn't break the sensor in the first place.

#### **5.2.4 Junction potential**

Some technicians attempt to deal with this slow temperature change by leaving the sensor resting in the first buffer solution long enough for it to cool to ambient temperature, typically 30 or more minutes. During this time, the large area reference of a well-designed industrial sensor is absorbing buffer solution. Eventually equilibrium is reached, but the actual millivoltage generated by the reference will be slightly different than when it is immersed in the process. After entering the first buffer value, the sensor is moved to the next buffer solution at which point the first and second buffers begin mixing in the porous large-area junction, creating a pH value that is some combination of the two rather than the predictable value expected of the second buffer. These two calibration points are then entered with some unrecognized degree of error and the sensor returned to service. After an hour or more, the buffer solutions stored in the porous reference will have been displaced by the process liquid, resulting in a slight offset in the indicated readout. The technician most often blames the sensor for exhibiting "drift", when in fact it is a flawed calibration technique that has loaded the sensor with buffer solution.

#### **5.2.5 The right way to calibrate hot process control sensors**

Generally speaking, the less a process control sensor is removed from its installed environment, the better. Optimally, it will be installed and allowed to stay at the same pressure and temperature until it has been expended. Unfortunately, they must occasionally be cleaned, or removed from shut-down process lines to be stored and kept hydrated.

Apart from these two situations, we recommend that the technician calibrate the process sensor by manually setting the "slope" (also known as efficiency or span) to a nominated value. We recommend any value from 95% to 100%, with 98% being a commonly used value. Some transmitters require that a new sensor be buffer calibrated before it is installed the first time, after which one can continue with process calibrations (or grab sample, single point standardization). While we consider this an unnecessary step, if your transmitter requires it you must do it, with the benefit that you will know that the new sensor is operating as expected. Fortunately, the new sensor will be at or near the same temperature as the buffers, so we will not experience the temperature related problems described above.

After the new sensor is buffered (if required) and installed in the process, we recommend that a sample be pulled from a location near to the measurement point and immediately measured with a high-quality, well-calibrated portable pH analyzer. This value should be entered into the transmitter via its “process calibration” method. Approximately 1 hour later, the technician should return and measure another local grab sample and re-standardize the sensor to match. This hour gives the sensor time to “equilibrate” to the process by coming up to temperature and achieving equilibrium with the chemistry. At this point the sensor should be reliably stable and useful for measurement and control. It should be periodically checked using the grab sample and portable analyzer on a frequency learned by experience. Each application is different leading to differing rates of consumption of the sensor’s electrolyte and/or damage to the glass electrode.

### 5.2.6 How do we know if the sensor is dead?

There are three methods to determine if a sensor is acceptably healthy. The first is the classic 2-point buffer calibration. We discourage this in most cases for the reasons already given, but some users or governmental bodies require this method.

The second is a close cooperation between the process control operators or engineers who monitor a sensor’s output via their DCS and the technicians who service the sensors. An operable sensor will show some degree of variation in pH, either thru actual changes in the process pH, or due to induced fluctuations resulting from variations in flow, air pockets, pressure changes, and so on. If the amplitude of the trace is smaller than experience indicates it should be, the operator or engineer should initiate a sensor inspection and cleaning request. If a sensor’s read-out is absolutely flat it is likely to be dead, although it may respond to cleaning if the process tends to coat over the tip.

The third method, which might also be routinely performed when the process control staff request a sensor inspection due to low-amplitude or flat-line, is to a) remove the sensor, b) clean it with the least aggressive method found to work with the specific process, and c) dip the sensor into 4pH buffer solution. If the transmitter readout indicates 4.5 or less within approximately 30 seconds, we know that the sensor is at least 80 % efficient, and that its response time is acceptable. If the readout does not go below 4.5, or if the time required is substantially in excess of 30 seconds, the sensor is telling you that it is suffering in some aspect and may require replacement in order to deliver a reliable and repeatable measurement. Experience will show how much the user can tolerate results different from 4.5 in 30 seconds and still expect a reliable measurement. These values are not absolutes, but are good guidelines to start with.

Note that the same test can be done using a 10pH buffer solution; looking for the readout to achieve 9.5 or higher within 30 seconds. The same health is indicated as with the 4pH buffer, but we prefer the 4pH buffer as the 10pH buffer tends to be unstable with age, oxidation, and temperature.

### 5.2.7 Summary

A well-designed process control sensor can be made to last longer and deliver a more reliable and repeatable measurement if it is process-standardized rather than buffer calibrated. Every process imposes a different cleaning technique, and consumes the sensor at a different rate. We encourage you to work with us, or your Honeywell representative to establish the best technique for your specific application.



## 6. Storage and Maintenance Procedures for pH and ORP Sensors

HB Series pH/ORP sensors require little care or maintenance. Simple guidelines follow:

During storage, sensors should be kept near room temperature and remain capped on the measuring end. These caps supplied from the factory are filled with a weak pH 7 buffer in order to keep the sensor wet. Sensors in storage should be checked semi-annually to assure that the cap retains moisture, if the pH 7 buffer evaporates, it may be replaced with ordinary tap water. BNC connectors, on the end of the sensor cable, must be isolated from moisture and corrosive gasses to assure that they remain clean, dry and free of corrosion.

Cleaning of pH and ORP sensors is easy. The reference usually does not require maintenance. Should a coating form over the exposed portion of the reference, it can usually be scraped off with a small penknife. Care must be taken not to break the glass or platinum measuring electrode, when scraping the reference.

Glass pH electrodes can be cleaned in a number of ways. Scaling, oils, and other stubborn coatings can usually be removed by soaking the reference in 3-10% HCL solution for a few minutes and then rinsing under tap water. Very heavy coatings may require more than one soaking. Simple cleaning of minor coatings can often be accomplished by directing a stream of clean tap water directly onto the glass. Wiping the glass with a clean, soft cloth may be sufficient with new sensors. Care must be taken with this approach as the glass may break when mishandled.

Oils or greases that can accumulate on the glass bulb may not be visible to the eye. To remove these, stir the sensor in a solvent such as isopropyl alcohol. Heavy build-up may require a number of alcohol cycles followed by wiping with a soft cloth. A dish soap may also be used.

ORP electrodes can be cleaned in the same manner as pH glass electrodes. In extreme cases, a fine abrasive such as "Bon-Ami, Comet, Boraxo, etc." can be used to polish the platinum tip. If the abrasive contains a bleaching agent, it may take 15 to 30 minutes to obtain a stable measurement.

Sensor cables should be run through conduit or be protected from the environment, they are not weatherproof. Do not allow cables and connectors to become wet, lay on the ground or across equipment, etc. Cables should not be abraded, pinched, twisted or sharply bent. BNC connectors must be insulated from electrical grounds and metal conduit. This can be easily accomplished by slipping the black vinyl cap, provided on the cable, over the connector. If the cap is missing, electrical tape is a good alternative.

## 7. Electrical Connections

### 7.1 Inputs and Outputs to the UDA2182

#### 7.1.1 Introduction

The analyzer can accept single or dual inputs from Honeywell Direct pH, pH Input from External Preamplifier, ORP, contacting conductivity and dissolved oxygen sensors.

- Two analog outputs standard
- One additional output optional
- Two electromechanical relays standard
- Two additional relays optional
- Two Digital Inputs

#### 7.1.2 Accessing the terminals

The wiring is easily accessible through the front and the boards can be pulled out to facilitate the wiring of sensor input.

1. Open the case.
2. Loosen the four captive screws on the front of the bezel.
3. Grasp the bezel on the right side. Lift the bezel gently and swing the bezel open to the left.

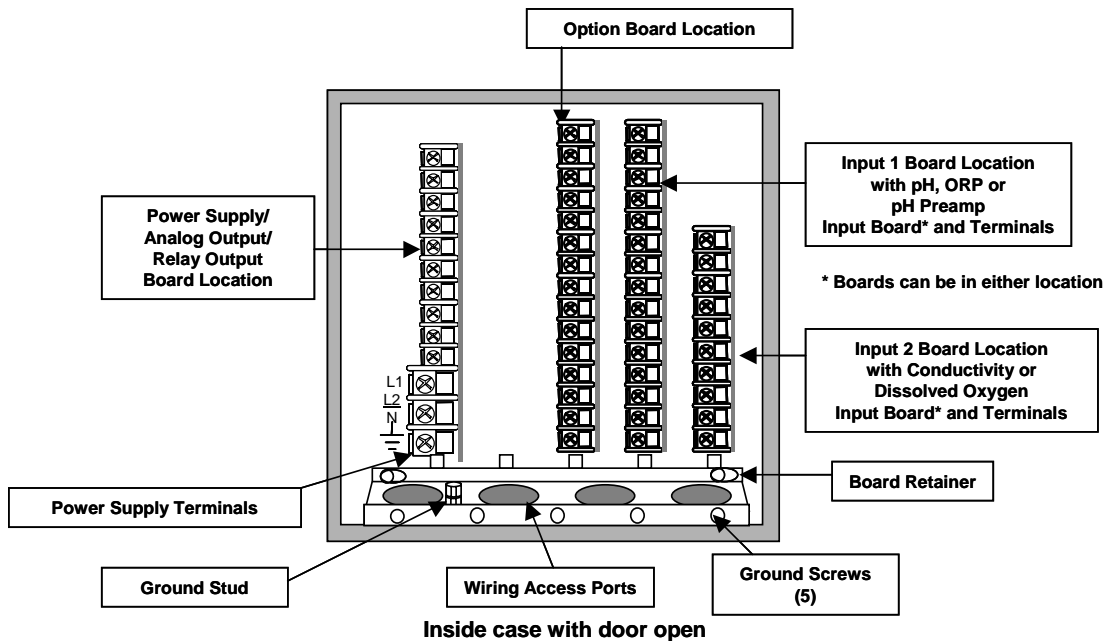





Figure 1-1 Wiring Terminals and Board Location



### **WARNING**

While the unit is powered, a potentially lethal shock hazard exists inside the case. Do not open the case while the unit is powered.

Table 7-1 Procedure for installing Input and Output wiring

Step	Action
1	Go to Configuration setup to view the displays showing analog input, relay, and analog output use. Note the assignments shown. You must wire the unit to match these assignments in order for the analyzer to work as expected.
<b>ATTENTION</b>	
  Turn off the power to the analyzer. More than one switch may be required to remove power.	
2	With power off, open the case: <ul style="list-style-type: none"> <li>• Loosen the four captive screws on the front of the bezel.</li> <li>• Grasp the bezel on the right side. Lift the bezel gently and swing the bezel open to the left.</li> </ul>
3	Refer to UDA2182 manual for the location of the terminal board retainer. Loosen the screws that hold the retainer and slide the retainer left until the retainer tabs disengage from the terminal boards.
4	Insert a screwdriver into the tab in the terminal board to be wired and pull out gently. Slide the board half way out. There is a notch in the terminal board into which you can slide the retainer tabs and hold the boards in place while wiring.
5	Connect the inputs from the electrode or cells to the terminals in accordance with the configuration setup assignments. Refer to the wiring diagram provided (Section 6.2) with the electrode or cell.
6	Analog outputs (In addition to the standard outputs, one more is available as an option). See Option Board Wiring in manual for UDA2182). Connect the outputs from the Analyzer terminals in accordance with the configuration setup assignments. Refer to the wiring diagrams provided with the field devices receiving the signals.
7	<p>If the relay outputs are to be used, leave the unit open and powered down. The relays can be used for Time Proportioning Output, Pulse Frequency Output, and Digital Output control as well as alarm annunciation. (In addition to the standard relays, two more are available as an option. See Option Board Wiring –in manual for UDA2182). Connect the outputs from the Analyzer terminals in accordance with the configuration setup assignments. Refer to the wiring diagrams provided with the external device.</p> <p>These relays can be programmed to de-energize or energize on alarm. Use the Maintenance configuration setup to specify relay state. (NOTE 1)</p>
 <b>CAUTION: Alarm circuits are not internally fused in the analyzer. Provision for fuses in external circuits is recommended.</b>	
8	Slide the retainer to the left then slide the terminal board back into place. Slide retainer to engage the tabs and tighten the screws.
9	Close the Bezel and secure four captive screws to a torque value of .20Nm (1.5 Lb-in). Power up the unit. Do not apply power until the bezel is closed.

Note 1: If set to de-energize on alarm, this means that when an alarm occurs (or the discrete control point becomes active), the relay coil will be de-energized. The NC contacts will then be closed and the NO contacts will be open. Conversely, during normal non-alarm operation (or when the control point is not active) the NC contacts will be open, and the NO contacts will be closed.

If de-energize on alarm is selected, a power loss will force all relays to the same position as an alarm condition.

### Identify Your Wiring Requirements

To determine the appropriate diagrams for wiring your analyzer, refer to the model number interpretation in this section. The model number of the analyzer is on the outside of the case.

### Wiring the Analyzer

Using the information contained in the model number, refer to the individual diagrams listed to wire the analyzer according to your requirements.

## 7.2 HB Series 551 pH/ORP Input Wiring Diagrams

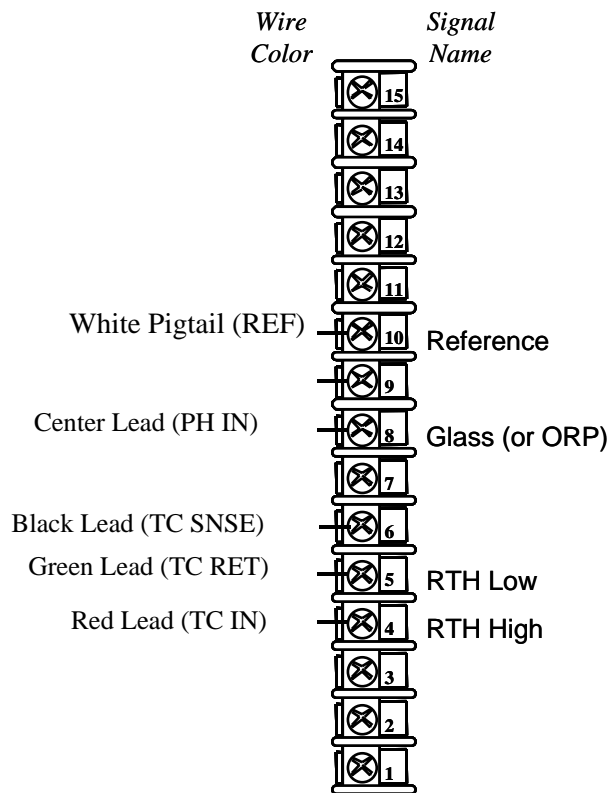

*Some cables have connectors on the leads.  
Cut off the connectors, skin and tin the leads  
and then wire to the screw terminals on the boards*



## 8. Pressure and Temperature Charts

### 8.1 HB Series Body Material Pressure and Temperature Ratings

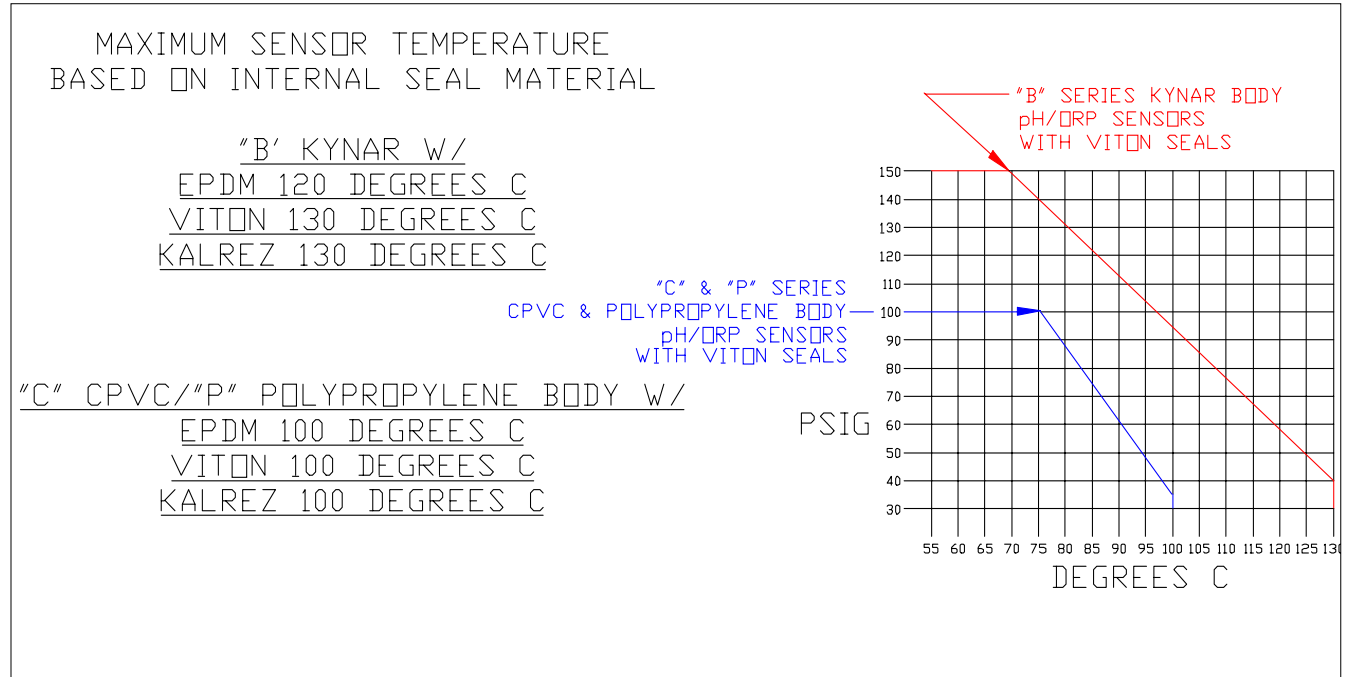



## 9. Drawings

### 9.1 HB551 Complete Assembly

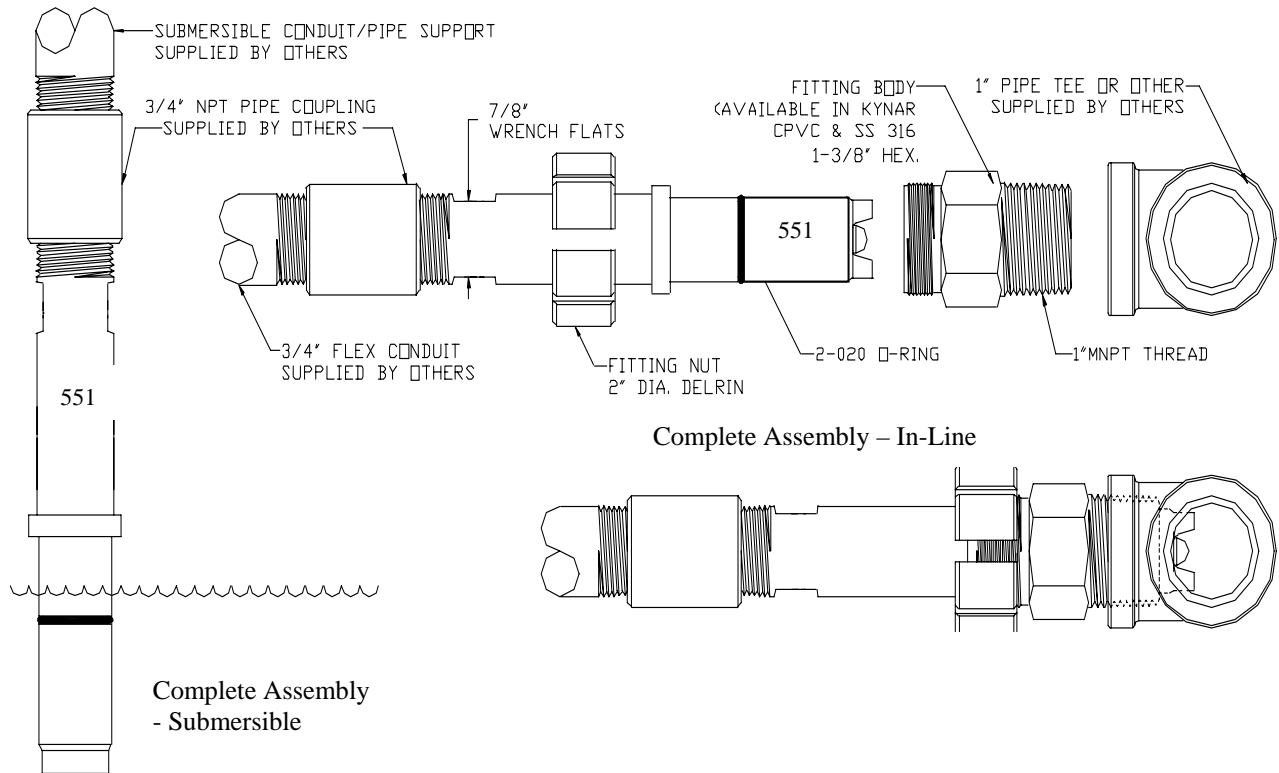

## 9.2 HB551 Nut-Loc Assembly

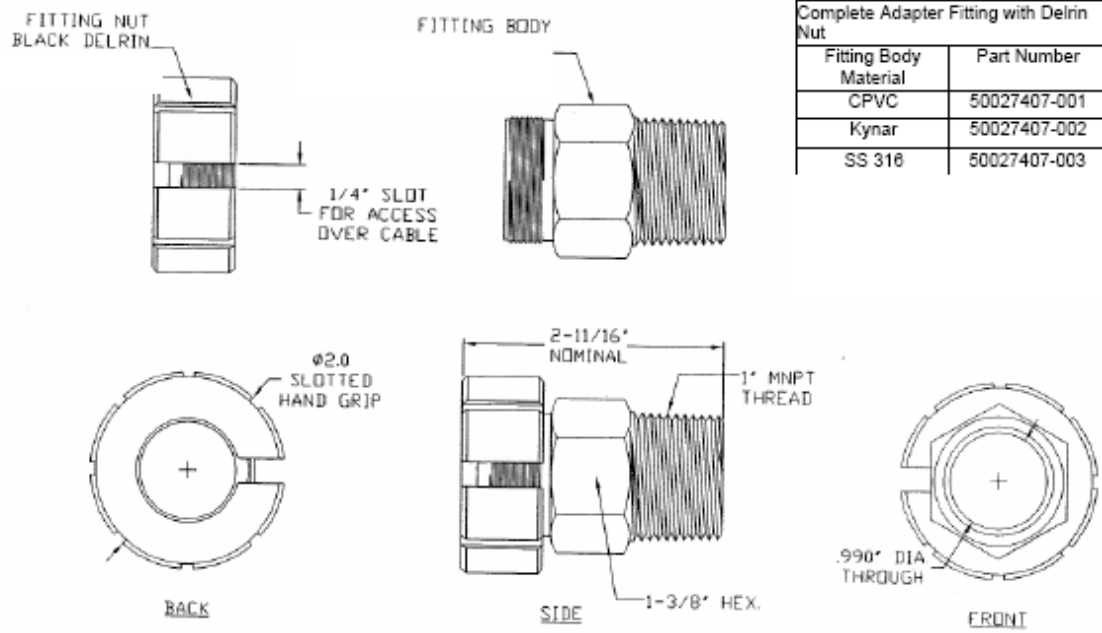

### 9.3 HB551 Dimension Drawing

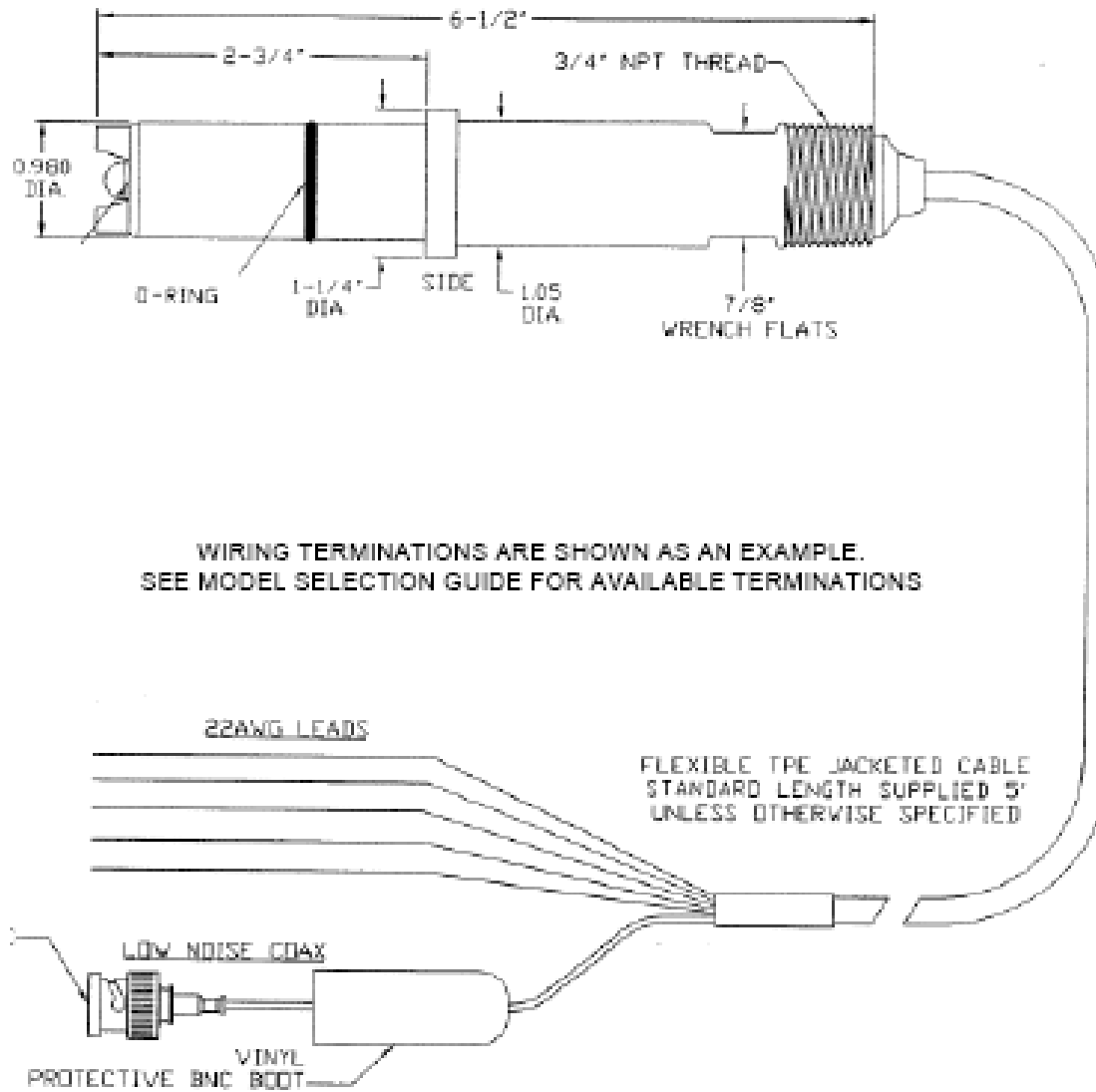





**Honeywell**

---

**Honeywell Field Solutions**

Honeywell

2500 Union Hills Rd., W

Phoenix, AZ 85027